

Swing Gate Wall Mounted Equipment Rack

19" Panel Mount



- Wall mounted rack door hinges to either side providing convenient access to the back of mounted equipment.
- Constructed of a steel frame and aluminum door with steel hinge pins.
- Easy, one person installation in about five (5) minutes.
- Mounting holes on 16" (406mm) centers.
- Door can be completely removed from frame after installation.
- EIA/ECA-310-E compliant with universal (5/8" (16mm), 5/8" (16mm), 1/2" (13mm)) mounting hole spacing.
- Available in 19" EIA width. (Other sizes available upon request)
- Available in mounting heights of 24" (609mm), 30" (762mm), 44" (1117mm), 54" (1371mm) and 79" (2006mm).
- Available in depths of 8 (203mm), 12" (305mm), 18" (457mm), and 25" (635mm).
- Packaged unassembled in protective carton suitable for parcel shipment.
- Integrated cable tie/cable wrap tie-down points.
- Load Rating: 150 Lbs. (68kg) (assumes suitable mounting surface)
- Finish ___: Telco Gray Powder Coat (TG), Flat Black Powder Coat (FB) or Silver Powder Coat (SL)
Other finishes are available upon request.
- UL listing - file number E235184

Rack Mounting Units Spacing Qty.

24" (609mm) height
10 RMU's

30" (762mm) height
13 RMU's

44" (1117mm) height
21 RMU's

54" (1371mm) height
27 RMU's



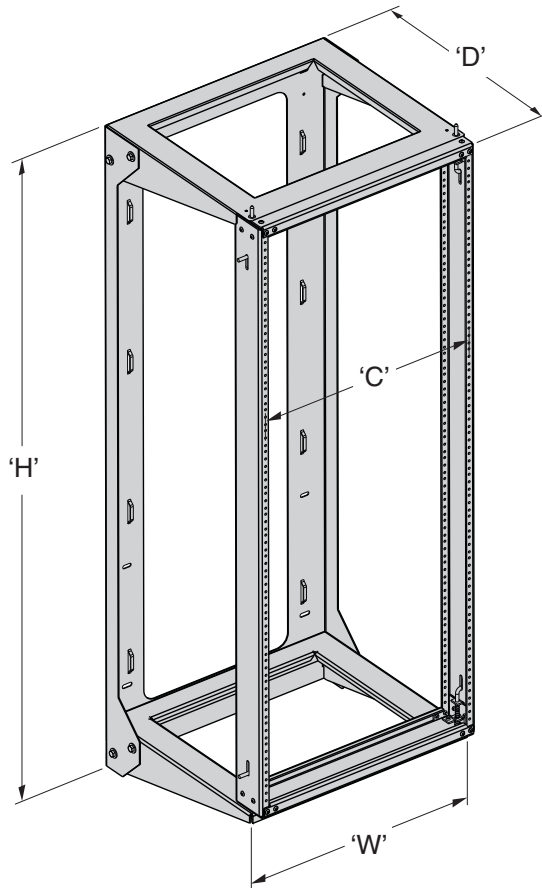
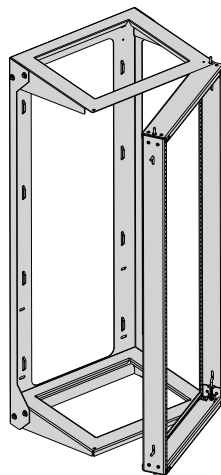
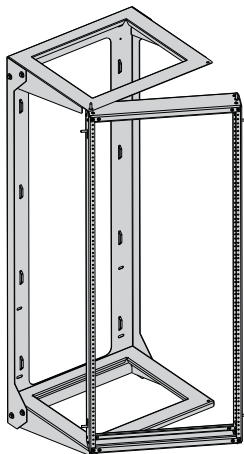

79" (2006mm) height
41 RMU's



Continued on page 27

Wall Mounted Swing Gate Equipment Rack

19" Panel Mount

| Part Number | Rack Width | | 'W' Overall Width | | 'C' Panel Mounting | | 'H' Overall Height | | 'D' Usable Depth | | Weight | |
|--|------------|-------|-------------------|-------|-----------------------------------|-------|-----------------------------------|--------|------------------|-------|--------|--------|
| | In. | (mm) | In. | (mm) | In. | (mm) | In. | (mm) | In. | (mm) | Lbs. | (kg) |
|  SB708192408 | 19" | (482) | 19.88" | (505) | 18 ⁵ / ₁₆ " | (465) | 24" | (609) | 8" | (203) | 21 | (9.5) |
| SB708192412 | 19" | (482) | 19.88" | (505) | 18 ⁵ / ₁₆ " | (465) | 24" | (609) | 12" | (305) | 23 | (10.4) |
|  SB708192418 | 19" | (482) | 19.88" | (505) | 18 ⁵ / ₁₆ " | (465) | 24" | (609) | 18" | (457) | 26 | (11.8) |
| SB708192425 | 19" | (482) | 19.88" | (505) | 18 ⁵ / ₁₆ " | (465) | 24" | (609) | 25" | (635) | 33 | (14.9) |
| SB708193008 | 19" | (482) | 19.88" | (505) | 18 ⁵ / ₁₆ " | (465) | 29 ³ / ₁₆ " | (741) | 8" | (203) | 30 | (13.6) |
| SB708193012 | 19" | (482) | 19.88" | (505) | 18 ⁵ / ₁₆ " | (465) | 29 ³ / ₁₆ " | (741) | 12" | (305) | 32 | (14.5) |
|  SB708193018 | 19" | (482) | 19.88" | (505) | 18 ⁵ / ₁₆ " | (465) | 29 ³ / ₁₆ " | (741) | 18" | (457) | 35 | (15.9) |
| SB708193025 | 19" | (482) | 19.88" | (505) | 18 ⁵ / ₁₆ " | (465) | 29 ³ / ₁₆ " | (741) | 25" | (635) | 39 | (17.7) |
| SB708194408 | 19" | (482) | 19.88" | (505) | 18 ⁵ / ₁₆ " | (465) | 43 ³ / ₁₆ " | (1096) | 8" | (203) | 32 | (14.5) |
| SB708194412 | 19" | (482) | 19.88" | (505) | 18 ⁵ / ₁₆ " | (465) | 43 ³ / ₁₆ " | (1096) | 12" | (305) | 34 | (15.4) |
|  SB708194418 | 19" | (482) | 19.88" | (505) | 18 ⁵ / ₁₆ " | (465) | 43 ³ / ₁₆ " | (1096) | 18" | (457) | 38 | (17.2) |
| SB708194425 | 19" | (482) | 19.88" | (505) | 18 ⁵ / ₁₆ " | (465) | 43 ³ / ₁₆ " | (1096) | 25" | (635) | 44 | (19.9) |
| SB708195408 | 19" | (482) | 19.88" | (505) | 18 ⁵ / ₁₆ " | (465) | 53 ⁵ / ₈ " | (1363) | 8" | (203) | 34 | (15.4) |
| SB708195412 | 19" | (482) | 19.88" | (505) | 18 ⁵ / ₁₆ " | (465) | 53 ⁵ / ₈ " | (1363) | 12" | (305) | 37 | (16.8) |
|  SB708195418 | 19" | (482) | 19.88" | (505) | 18 ⁵ / ₁₆ " | (465) | 53 ⁵ / ₈ " | (1363) | 18" | (457) | 40 | (18.1) |
| SB708195425 | 19" | (482) | 19.88" | (505) | 18 ⁵ / ₁₆ " | (465) | 53 ⁵ / ₈ " | (1363) | 25" | (635) | 46 | (20.8) |
| SB708197908 | 19" | (482) | 19.88" | (505) | 18 ⁵ / ₁₆ " | (465) | 78 ³ / ₁₆ " | (1985) | 8" | (203) | 39 | (17.7) |
| SB708197912 | 19" | (482) | 19.88" | (505) | 18 ⁵ / ₁₆ " | (465) | 78 ³ / ₁₆ " | (1985) | 12" | (305) | 41 | (18.6) |
| SB708197918 | 19" | (482) | 19.88" | (505) | 18 ⁵ / ₁₆ " | (465) | 78 ³ / ₁₆ " | (1985) | 18" | (457) | 45 | (20.4) |
| SB708197925 | 19" | (482) | 19.88" | (505) | 18 ⁵ / ₁₆ " | (465) | 78 ³ / ₁₆ " | (1985) | 25" | (635) | 51 | (23.1) |

Finish ___: Telco Gray Powder Coat (TG) or Flat Black Powder Coat (FB)

Other finishes are available upon request.



FB is a popular Bee List item